

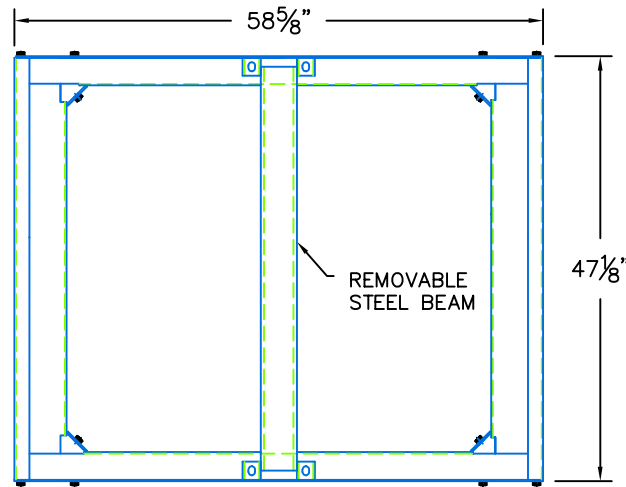

# MADRUGA IRON WORKS, INC.

Metal Fabrication and Machining

305 GANDY DANCER, TRACY, CA 95377 Ph: (209) 832-7003 Fax: (209) 832-2444  
www.madrugaironworks.com



FRAME - PLAN VIEW

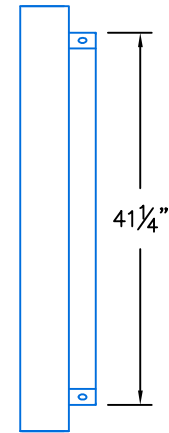

END VIEW

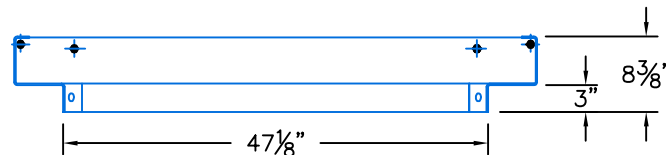

SIDE VIEW

## 42" x 48" (Nominal) MIW Style Aluminum Cover Assembly

Loading: AASHTO H-20 - Traffic Loading  
Live Load: 16,000 lb. Wheel Load -  
Impact: 0.00%  
(NOT FOR STEET USE)

### NOTES:

1. ALUMINUM, SLIP RESISTANT COVER
2. 90° OPENING
3. BOLT-DOWN (4-PLACES)
4. HINGED, TORSION SPRING ASSIST
5. REMOVABLE CENTER BEAM
6. ADJUSTABLE FRAME
7. GALVANIZED FRAME

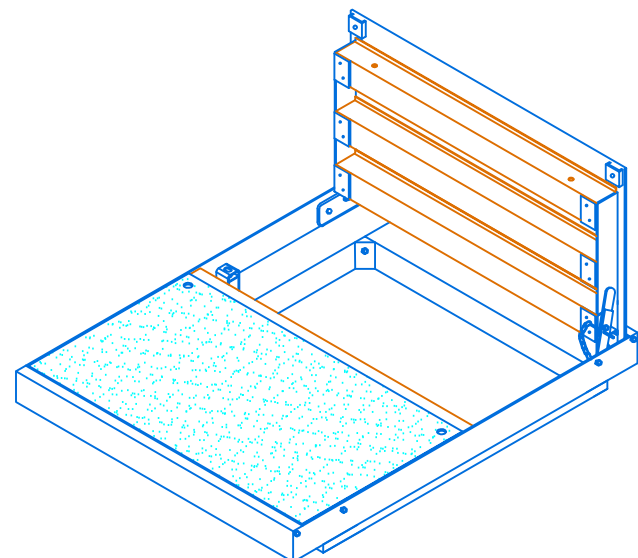

ISOMETRIC DETAIL