

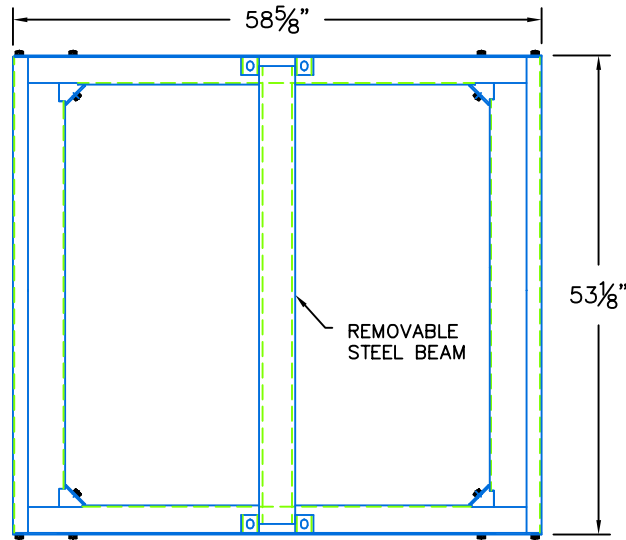

MADRUGA IRON WORKS, INC.

Metal Fabrication and Machining

305 GANDY DANCER, TRACY, CA 95377 Ph: (209) 832-7003 Fax: (209) 832-2444
www.madrugaironworks.com



FRAME - PLAN VIEW

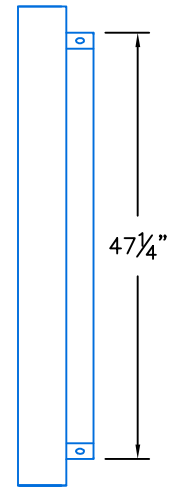

END VIEW

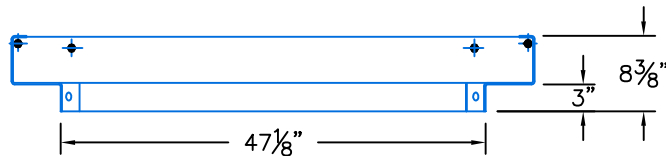

SIDE VIEW

48" x 48" (Nominal) MIW Style Aluminum Cover Assembly

Loading: AASHTO H-20 - Traffic Loading
Live Load: 16,000 lb. Wheel Load -
Impact: 0.00%
(NOT FOR STEET USE)

NOTES:

1. ALUMINUM, SLIP RESISTANT COVER
2. 90° OPENING
3. BOLT-DOWN (4-PLACES)
4. HINGED, TORSION SPRING ASSIST
5. REMOVABLE CENTER BEAM
6. ADJUSTABLE FRAME
7. GALVANIZED FRAME

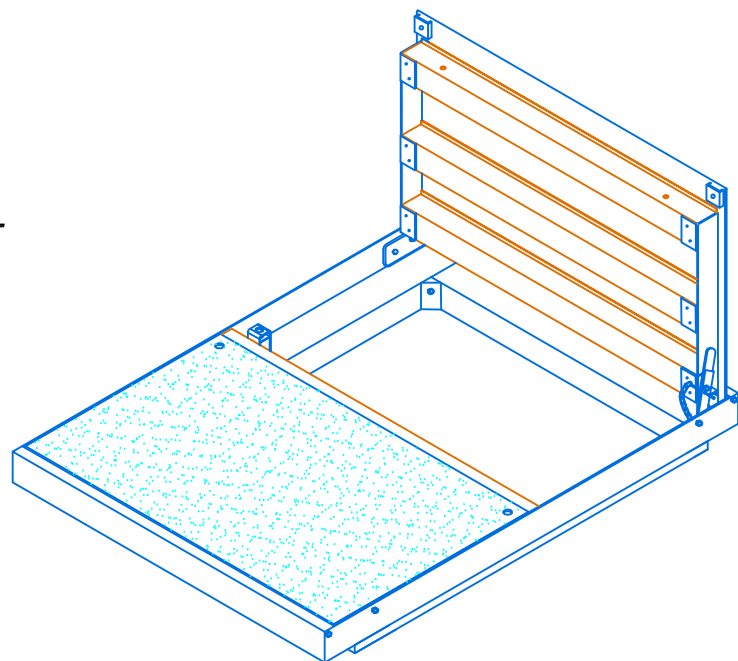

ISOMETRIC DETAIL