



MADRUGA IRON WORKS, INC.

Metal Fabrication and Machining

305 GANDY DANCER, TRACY, CA 95377

Ph: (209) 832-7003

Fax: (209) 832-2444

www.madrugaironworks.com

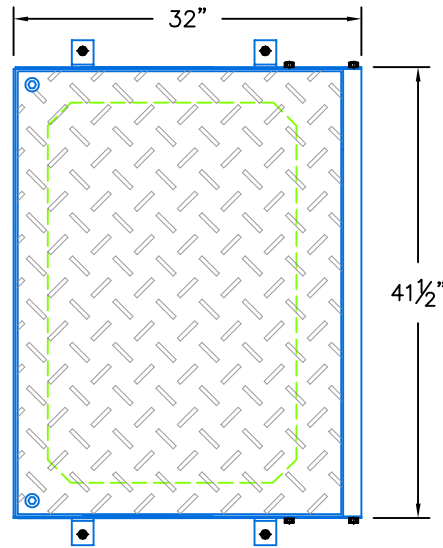

PLAN VIEW

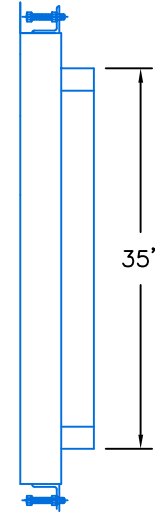

END VIEW

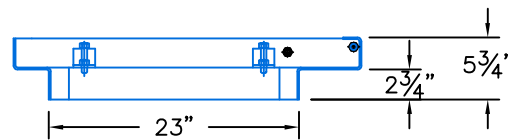

SIDE VIEW

24" x 36" (Nominal) MIW Style Frame & Cover Assembly

Approximate Weight: XXX lbs

Loading: AASHTO H-20 - Traffic Loading

Live Load: 16,000 lb. Wheel Load -

Impact: 0.00%

NOTES:

1. STEEL, DIAMOND PLATE COVER
2. CLEAR OPENING
3. BOLT-DOWN (2-PLACES)
4. HINGED
5. TORSION ASSIST
6. ADJUSTABLE FRAME
7. PAINTED (DARK GRAY)

AVAILABLE OPTIONS:

1. GALVANIZED FINISH
2. NON-SLIP PLATE, GALVANIZED OR PAINTED
3. SAND EPOXY FINISH
4. LATCH HOLD DOWN
5. CAST-IN FRAME

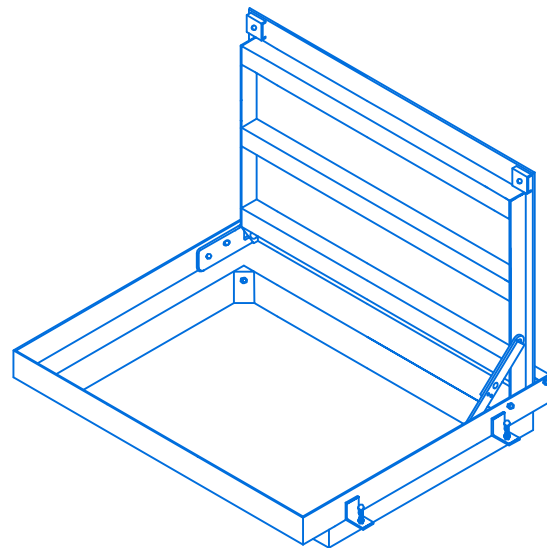

ISOMETRIC DETAIL