



MADRUGA IRON WORKS, INC.

Metal Fabrication and Machining

305 GANDY DANCER, TRACY, CA 95377

Ph: (209) 832-7003

Fax: (209) 832-2444

www.madrugaironworks.com

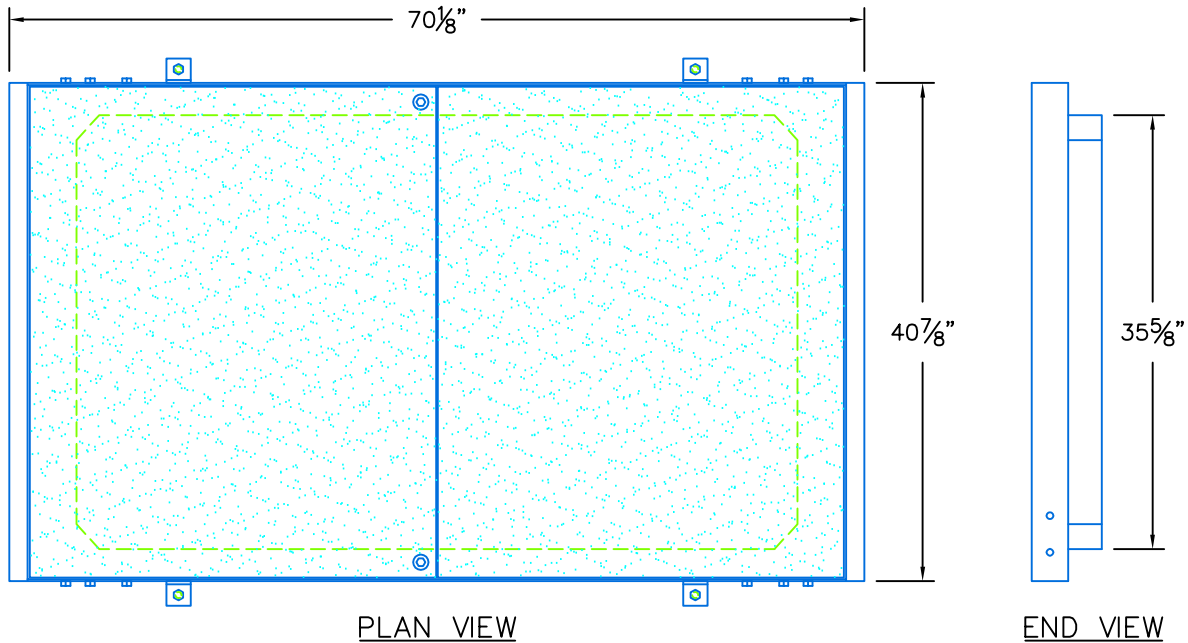

36" x 60" (Nominal) Telephone Style Frame & Cover Assembly

Approximate Weight: 370 lbs

Loading: Pedestrian Loading

Live Load: 300 lb/sq. ft. -

Impact: 0.00%

NOTES:

1. STEEL, NON-SLIP COVER
2. CLEAR OPENING
3. BOLT-DOWN (2-PLACES)
4. HINGED
5. TORSION ASSIST
6. ADJUSTABLE FRAME
7. PAINTED (LIGHT GRAY)

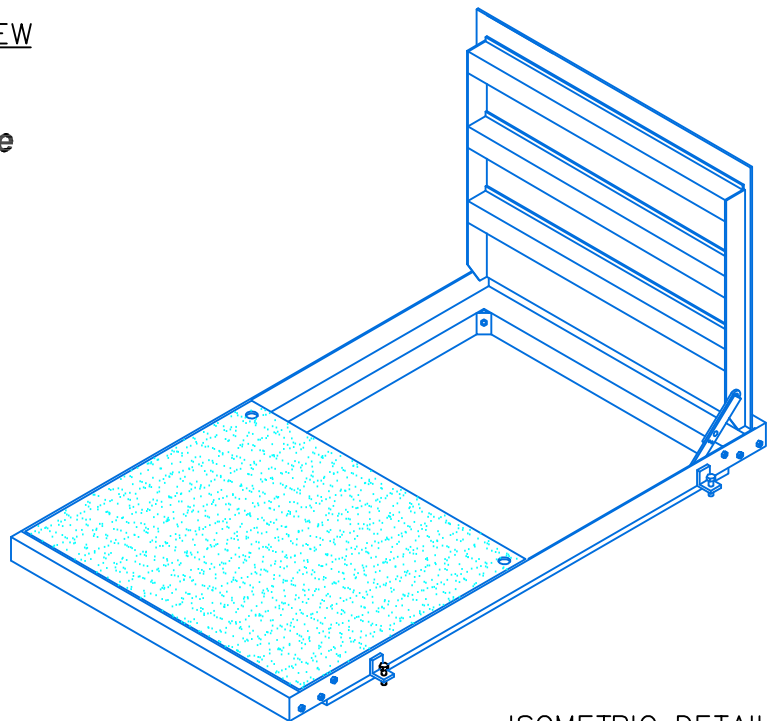

ISOMETRIC DETAIL